

## INSTALLATION INSTRUCTIONS

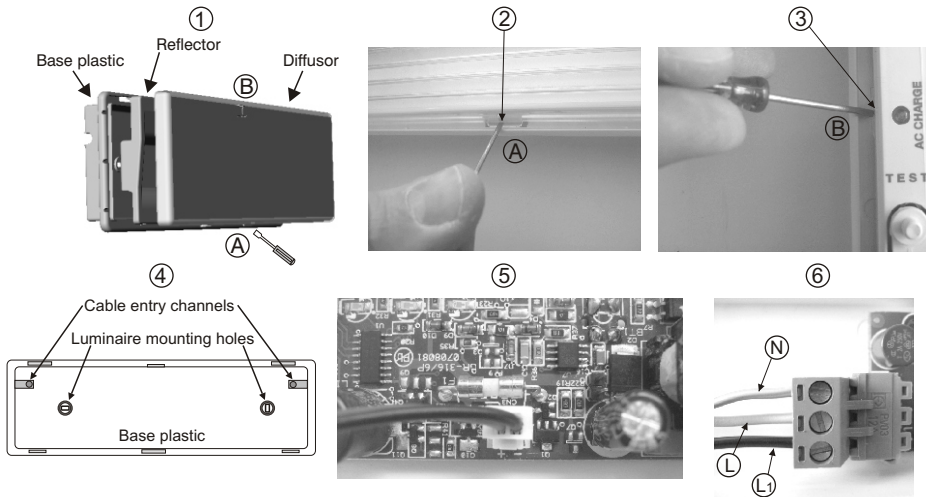

- ① To install the luminaire you must dismantle it to 3 parts.
- ② Place a flat blade screwdriver in the area **A** to release the diffuser's plastic hook.
- ③ Place a flat blade screwdriver in the area **B** to release the reflector's plastic hook.
- ④ Use the included mounting parts to mount the base plastic. Pass the mains cable thru a cable entry channel.
- ⑤ Place the battery's connector to the corresponding connector on the P.C.B.
- ⑥ Connect the mains cables to the respective detachable terminal block. N for neutral, L for live wire and L1 for the maintained operation. The L1 wire can be connected to an external switch to control the maintained or non maintained operation of the luminaire. For permanent maintained operation use two wires to power the luminaire, N for neutral and L for live wire, and link the L and L1.
- ⑦ Refit the removed parts in steps 2 and 3 (mind the correct orientation) and the luminaire is ready to operate.

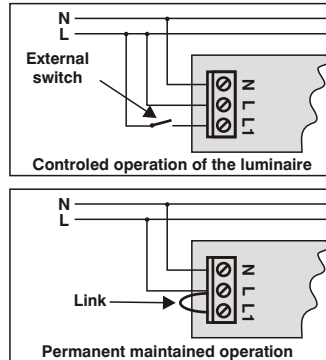

**NOTE:** LED= Light Emitting Diode

### LABELING EXPLANATION:

- X:** Self contained
- 1:** Maintained
- A:** Including test device
- 90:** 1.5 hour duration

All the types of **Easy Light** series, are also produced with a new designed crystal with **GR-XXX/CRV** code, for example **GR-315/4P/CRV**.

## SELF-TESTING MAINTAINED EMERGENCY LUMINAIRES

TECHNICAL CHARACTERISTICS	GR-315/4P	GR-315/6P
OPERATION VOLTAGE	220-240V AC/50-60Hz	
MAXIMUM POWER CONSUMPTION	13 VA	16.5 VA
BATTERIES (Ni-Cd)	4.8V/1.5Ah	4.8V/3Ah
BATTERY PROTECTION	From overcharge and full discharge	
INDICATIONS - CONTROLS	Charge, lamp fault, fault indication LED, TEST button	
CHARGING TIME	24h	
MINIMUM AUTONOMOUS DURATION	90min	
ILLUMINATION SOURCE	4 power LED's	6 power LED's
ILLUMINATION (230V / EMERGENCY)	125/250lm	200/400lm
DEGREES OF COVER PROTECTION	IP 40	
PRODUCED IN ACCORDANCE WITH	EN 60598-1, EN 60598-2-22	
OPERATION TEMPERATURE RANGE	0 to 40 °C	
RELATIVE HUMIDITY	Up to 95%	
CONSTRUCTION MATERIALS	Bayblend FR3010, transparent polycarbonate	
EXTERNAL DIMENSIONS	350 x 134 x 45 mm (CRV 362 x 134 x 58 mm)	
TYPICAL WEIGHT	740gr.	840gr.
GUARANTEE	3 years (1 year for the battery)	

### GENERAL

These luminaires are used in places where emergency luminaires are needed. Each luminaire must be permanently connected to mains power supply. In normal operation the led strip lights and the battery is charging. In case of a mains power supply failure the luminaire will light the led strip automatically in emergency mode. When the mains power supply is restored the device turns to normal operation.

### INSTALLATION

To install the luminaire follow the installation instructions in page 4.

### Battery Cut-off

The luminaire enters in this operation when the mains power supply fails and battery has lost its energy. During this operation the luminaire enters the idle state and battery consumption is negligible, in order to be protected from deep discharge.

### Battery charging

The battery charging is completely controlled. In this case, is achieved the perfect battery maintenance, as well as the elongation of its duration. When the battery has completely charged, it charges with a maintenance current.

### Manual Test

The manual test can be conducted only if the main power supply and the battery is

connected. By pressing the test button briefly an operation test is initiated. During this test period all indication LEDs are OFF.

### Automatic test

This test includes all the operations that provide the manual test and is conducted automatically every 15 days. In order to be performed, the main power supply and the battery should be connected.

### Automatic Autonomous Test

The Automatic autonomous Test is conducted and measures the luminaire's back up operation. This test is conducted automatically every six months. In order to be performed, the main power supply and the battery should be connected (the battery should be charged). If the battery is not charged, the test is postponed until the battery is completely charged.

### Back Up Operation

The autonomous duration of battery during emergency mode is at least the one that is stated in the list of the first page. During emergency mode, a LED strip test is also performed.

### Resetting Errors

Push the Test button for 5 seconds, to extinguish all the indicated LED errors. Then the luminaire enters regular operation mode.

**Indication LED status (with connected mains power supply).**

### AC Charge

**On:** Good charge current.

**Off:** No battery (No charging current or disconnected battery).

### Lamp fault

On: faulty LED strip.

Off: Good LED strip.

### Fault

Off: Battery OK.

**Blink (With AC Charge LED ON):** Autonomy or low battery problem

**(the battery must be replaced).**

**Blink (With AC Charge LED Off):**

No charging current or disconnected battery.

2. The device must be connected to the mains power supply thru a fuse dependent by the total amount of the line's power load.

3. In case of inactive use for a period greater than 2 months, disconnect the battery by pulling out the battery's connector.

4. **It is not allowed to discard batteries in to common trash bins, they must be discarded only in battery recycling points. Do not burn.**

### ATTENTION!!!

1. Operations for installation, maintenance or testing must be done by authorized personnel only.

## Installation methods

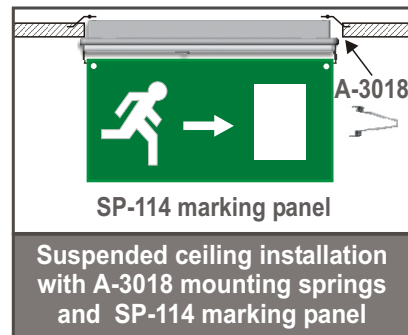
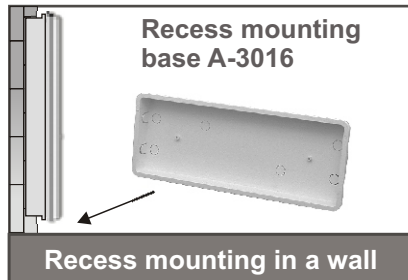
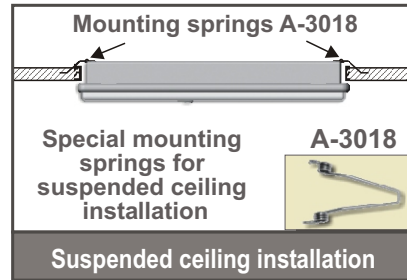
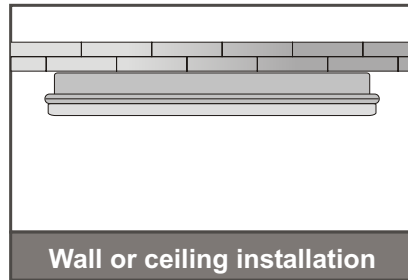

### Mounting methods

All "Easy Light" can be mounted either surface or recess mounted in walls or suspended ceilings. For recess mounted installations, special accessories are required which can be found in the catalog and must be ordered separately.

### Suspended ceiling installation.

On the bottom of the base plastic of the Easy light luminaire there are two H shaped cut outs. These are used to install the A-3018 mounting springs.

1. With a sharp tool remove the appropriate plastic pieces to fit the mounting springs. First place the edges of the mounting spring to the respective holes and install the one end of the coil to the support axis.

2. Install the other end of the coil to the other support axis.

3. Bend the springs and place the luminaire to the respective suspended ceiling's hole.

*The luminaire's placement to the suspended ceiling must be done after the connection with power supply cables.*

### Recess mounting in a wall

The special mounting base (A-3016) can be built in the wall and on it can be mounted the luminaire with the A-3016 included screws, following the installation instructions of the luminaire. The mounting base contains pre-etched holes for cable entry that are aligned with the cable entry holes of the luminaire.

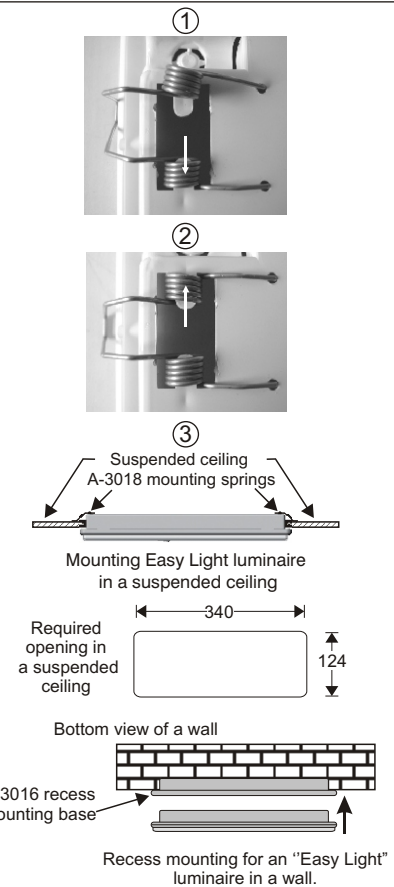

### PLACING A-CRV PARTS

To install the curve crystal A-CRV you must first install the included plastic extension to mount it on the TEST button.

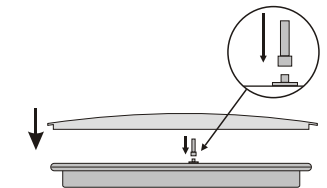

### MARKING PANEL SP-114

A marking panel SP-114 can be installed on the luminaire in 3 different locations. This marking panel is installed perpendicular to the diffuser of the luminaire, as shown in the pictures below. The panel is pre-printed and has a plastic accessory on each side that is used to fasten the panel to the luminaires. There are 2 arrow stickers that can be placed in each side of the marking panel to point to the desired direction.



### Placing the SP-114 marking panel

Place the plastic mounting accessories of the marking panel as shown in pictures.

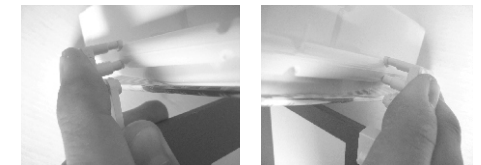

**NOTE!!** This marking panel (SP type) can not be installed on CRV luminaires.